

# *RX-497*

---

*Stereo Receiver*

*Récepteur stéréo*

OWNER'S MANUAL  
MODE D'EMPLOI  
BEDIENUNGSANLEITUNG  
BRUKSANVISNING  
GEBRUIKSAANWIJZING  
ИНСТРУКЦИЯ ПО ЭКСПЛУАТАЦИИ

# CAUTION: READ THIS BEFORE OPERATING YOUR UNIT.

- 1 To assure the finest performance, please read this manual carefully. Keep it in a safe place for future reference.
- 2 Install this sound system in a well ventilated, cool, dry, clean place – away from direct sunlight, heat sources, vibration, dust, moisture, and/or cold. Allow ventilation space of at least 30 cm on the top, 20 cm on the left and right, and 20 cm on the back of this unit.
- 3 Locate this unit away from other electrical appliances, motors, or transformers to avoid humming sounds.
- 4 Do not expose this unit to sudden temperature changes from cold to hot, and do not locate this unit in an environment with high humidity (i.e. a room with a humidifier) to prevent condensation inside this unit, which may cause an electrical shock, fire, damage to this unit, and/or personal injury.
- 5 Avoid installing this unit where foreign objects may fall onto this unit and/or this unit may be exposed to liquid dripping or splashing. On the top of this unit, do not place:
  - Other components, as they may cause damage and/or discoloration on the surface of this unit.
  - Burning objects (i.e. candles), as they may cause fire, damage to this unit, and/or personal injury.
  - Containers with liquid in them, as they may fall and liquid may cause electrical shock to the user and/or damage to this unit.
- 6 Do not cover this unit with a newspaper, tablecloth, curtain, etc. in order not to obstruct heat radiation. If the temperature inside this unit rises, it may cause fire, damage to this unit, and/or personal injury.
- 7 Do not plug in this unit to a wall outlet until all connections are complete.
- 8 Do not operate this unit upside-down. It may overheat, possibly causing damage.
- 9 Do not use force on switches, knobs and/or cords.
- 10 When disconnecting the power cable from the wall outlet, grasp the plug; do not pull the cable.
- 11 Do not clean this unit with chemical solvents; this might damage the finish. Use a clean, dry cloth.
- 12 Only voltage specified on this unit must be used. Using this unit with a higher voltage than specified is dangerous and may cause fire, damage to this unit, and/or personal injury. YAMAHA will not be held responsible for any damage resulting from use of this unit with a voltage other than specified.
- 13 To prevent damage by lightning, keep the power cord and outdoor antennas disconnected from a wall outlet or the unit during a lightning storm.
- 14 Do not attempt to modify or fix this unit. Contact qualified YAMAHA service personnel when any service is needed. The cabinet should never be opened for any reasons.
- 15 When not planning to use this unit for long periods of time (i.e. vacation), disconnect the AC power plug from the wall outlet.
- 16 Install this unit near the AC outlet and where the AC power plug can be reached easily.
- 17 Be sure to read the “TROUBLESHOOTING” section on common operating errors before concluding that this unit is faulty.
- 18 Before moving this unit, press MASTER ON/OFF to release it outward to the OFF position, and disconnect the AC power plug from the wall outlet.
- 19 **VOLTAGE SELECTOR** (Asia and General models only)  
The VOLTAGE SELECTOR on the rear panel of this unit must be set for your local main voltage BEFORE plugging into the AC main supply. Voltages are:  
General model .....AC 110/120/220/230–240 V, 50/60 Hz  
Asia model .....AC 220/230–240 V, 50/60 Hz

## WARNING

TO REDUCE THE RISK OF FIRE OR ELECTRIC SHOCK, DO NOT EXPOSE THIS UNIT TO RAIN OR MOISTURE.

As long as this unit is connected to the AC wall outlet, it is not disconnected from the AC power source even if you turn off this unit by MASTER ON/OFF, or MAIN ZONE ON/OFF and ZONE 2 ON/OFF. In this state, this unit is designed to consume a very small quantity of power.

# CONTENTS

## INTRODUCTION

<b>FEATURES</b> .....	<b>2</b>
<b>SUPPLIED ACCESSORIES</b> .....	<b>2</b>
<b>CONTROLS AND FUNCTIONS</b> .....	<b>3</b>
Front panel .....	3
Front panel display .....	5
Rear panel .....	6
Remote control .....	7
Installing batteries in the remote control .....	9
Using the remote control .....	9

## PREPARATION

<b>CONNECTIONS</b> .....	<b>10</b>
Connecting speakers .....	11
Connecting the AM and FM antennas .....	12
Connecting the power supply cord .....	14
Turning on and off this unit .....	14

## BASIC OPERATION

<b>PLAYING AND RECORDING</b> .....	<b>15</b>
Playing a source .....	15
Adjusting the tonal quality .....	16
Recording a source .....	17
Using the sleep timer .....	18
Muting the sound output .....	19
<b>FM/AM TUNING</b> .....	<b>20</b>
Automatic tuning .....	20
Manual tuning .....	21
Automatic preset tuning .....	22
Manual preset tuning .....	24
Selecting preset stations .....	25
Exchanging preset stations .....	25
<b>RADIO DATA SYSTEM</b>	
<b>(EUROPE MODEL ONLY)</b> .....	<b>26</b>
Receiving Radio Data System stations .....	26
Changing the Radio Data System mode .....	26
PTY SEEK function .....	27
EON function .....	28

## ADVANCED OPERATION

<b>ADVANCED SETUP</b> .....	<b>29</b>
Changing the ADVANCED SETUP menu parameters .....	29
Switching the remote control ID .....	30
<b>ZONE 2</b> .....	<b>31</b>
Connecting the Zone 2 components .....	31
Controlling Zone 2 .....	32
<b>REMOTE CONTROL FEATURES</b> .....	<b>33</b>
Control area .....	33
Controlling other components .....	34
Setting remote control codes .....	35

## ADDITIONAL INFORMATION

<b>TROUBLESHOOTING</b> .....	<b>36</b>
<b>SPECIFICATIONS</b> .....	<b>39</b>

INTRODUCTION

PREPARATION

BASIC  
OPERATION

ADVANCED  
OPERATION

ADDITIONAL  
INFORMATION

English

# FEATURES

## Built-in 2-channel power amplifier

- ◆ Minimum RMS output power  
75 W + 75 W (8 Ω), 0.04% THD, 20 Hz to 20 kHz
- ◆ Highly dynamic power, low impedance drive capability

## Sophisticated AM/FM tuner

- ◆ 40-station random access preset tuning
- ◆ Automatic preset tuning
- ◆ Preset station exchanging capability
- ◆ Radio Data System tuning capability  
(Europe model only)

## Other features

- ◆ PURE DIRECT button used to reproduce the purest source sound
- ◆ Continuously variable loudness control
- ◆ Sleep timer
- ◆ Remote control capability
- ◆ Zone 2 remote control (sold separately) capability
- ◆ Zone 2 custom installation facility

•  indicates a tip for your operation.

- Some operations can be performed by using either the buttons on the front panel of this unit or those on the remote control. In case the button names differ between this unit and the remote control, the names of the buttons on the remote control are given in parentheses).
- This manual is printed prior to production. Design and specifications are subject to change in part as a result of improvements, etc. In case of differences between the manual and the product, the product has priority.

# SUPPLIED ACCESSORIES

Please check that you received all of the following parts.

## Remote control

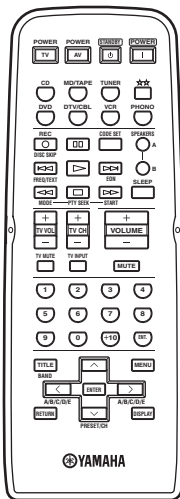

## Batteries (x2) (AA, R6, UM-3)

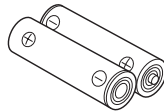

## AM loop antenna



## Indoor FM antenna (U.S.A., Canada and General models)

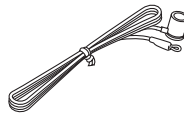

## Indoor FM antenna (Europe and Australia models)

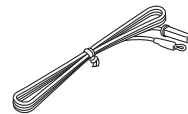

# CONTROLS AND FUNCTIONS

## Front panel

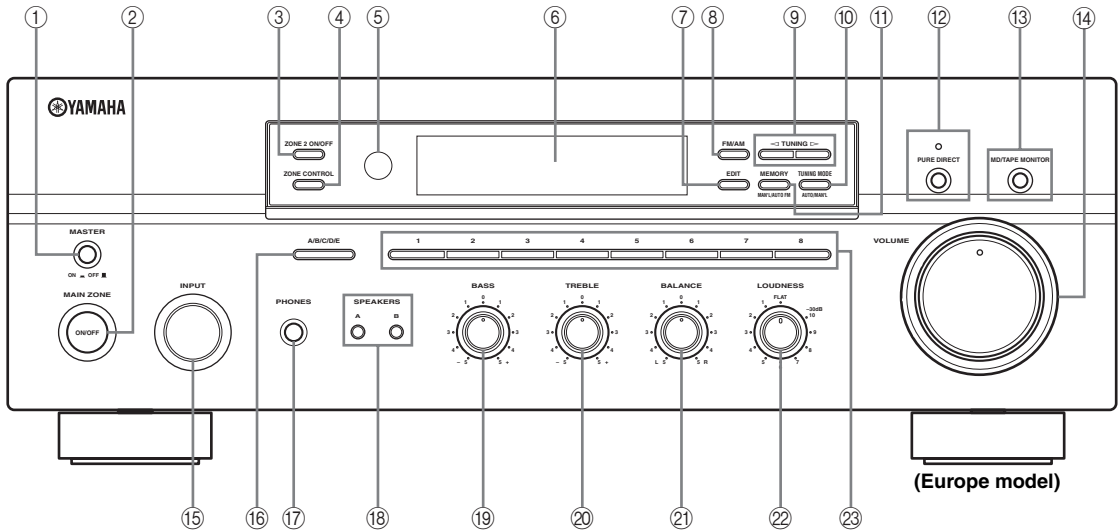

### ① MASTER ON/OFF

Press inward to the ON position to turn on the power of this unit. Press again to release it outward to the OFF position to turn off this unit. See page 14 for details.

#### Note

Even when this unit is turned off, this unit consumes a small amount of power to preserve the memory.

#### Memory back-up

The memory back-up circuit prevents the stored data from being lost. However, the stored data will be lost if the power cord is disconnected from the AC wall outlet for more than one week.

### ② MAIN ZONE ON/OFF

Turns on Main Zone of this unit or sets it to the standby mode. See page 14 for details.

#### Notes

- This switch is operational only when MASTER ON/OFF is pressed inward to the ON position.
- In the standby mode, this unit consumes a small amount of power to receive infrared signals from the remote control.

### ③ ZONE 2 ON/OFF

Turns on Zone 2 or set it to the standby mode. When Zone 2 is turned on, signals are output at the ZONE 2 OUT jacks.

#### Note

This switch is operational only when MASTER ON/OFF is pressed inward to the ON position.

### ④ ZONE CONTROL

Press to control the input source of Zone 2.

#### Notes

- This button is operational only when Zone 2 is turned on.
- When you press this button, the ZONE 2 indicator flashes in the front panel display for approximately 5 seconds. Select the input source of Zone 2 while the indicator is flashing.
- You can select the preset station when TUNER is selected as the input source of Zone 2.

### ⑤ Remote control sensor

Receives infrared signals from the remote control.

#### Note

Switch the remote control ID between ID1 and ID2 when using multiple YAMAHA receivers or amplifiers (see pages 29, 30).

### ⑥ Front panel display

Shows information about the operational status of this unit.

**⑦ EDIT**

Exchanges the assignment of two preset stations with each other when TUNER is selected as the input source (see page 25).

**⑧ FM/AM**

Switches the reception band between AM and FM when TUNER is selected as the input source (see page 20).

**⑨ TUNING </>**

Selects the tuning frequency when TUNER is selected as the input source (see page 20).

**⑩ TUNING MODE**

Switches the tuning mode between automatic (the AUTO indicator turns on as a result) and manual (the AUTO indicator turns off as a result) when TUNER is selected as the input source.

**⑪ MEMORY**

Stores a station in the system memory (see page 24). Sets this unit to the automatic preset tuning mode (see page 22).

**⑫ PURE DIRECT and indicator**

Allows you to listen to a source in the purest possible sound. The indicator above it lights up when this function is turned on (see page 16).

**⑬ MD/TAPE MONITOR**

Allows you to listen to the sound played back on the component connected to the MD/TAPE jacks on the rear panel of this unit.

When the tape deck is used for recording, you can also monitor the sound being recorded.

The MD/TAPE MON indicator in the front panel display lights up when this function is turned on.

**Notes**

- When this function is on (the indicator lights up), MD/TAPE cannot be selected with the INPUT selector.
- To listen to the source selected with the INPUT selector, press again to turn off the function (the indicator turns off as a result).
- When MD/TAPE is selected with the INPUT selector, this function will not turn on even if MD/TAPE MONITOR is pressed.

**⑭ VOLUME**

Increases or decreases the sound output level.

**Note**

This does not affect the OUT (REC) level.

**⑮ INPUT selector**

Selects the input source you want to listen to or watch.

**⑯ A/B/C/D/E**

Selects the preset station group (A to E) when TUNER is selected as the input source (see page 23).

**⑰ PHONES jack**

Outputs audio for private listening with your headphones.

**Note**

Press SPEAKERS A/B so that the SP A/B indicators turn off before you connect your headphones to the PHONES jack.

**⑱ SPEAKERS A/B**

Turns on or off the speaker set connected to the SPEAKERS A and/or SPEAKERS B terminals on the rear panel each time the corresponding button is pressed (see page 15).

**⑲ BASS**

Increases or decreases the low frequency response. The 0 position produces a flat response (see page 16).

**⑳ TREBLE**

Increases or decreases the high frequency response. The 0 position produces a flat response (see page 16).

**㉑ BALANCE**

Adjusts the sound output balance of the left and right speakers to compensate for sound imbalances caused by speaker locations or listening room conditions (see page 16).

**㉒ LOUDNESS**

Retains a full tonal range at any volume level to compensate for the human ears' loss of sensitivity to high and low-frequency ranges at a low volume level (see page 16).

**㉓ Preset station number buttons (1 to 8)**

Selects the preset station number (1 to 8) directly when TUNER is selected as the input source (see page 25).

## Front panel display

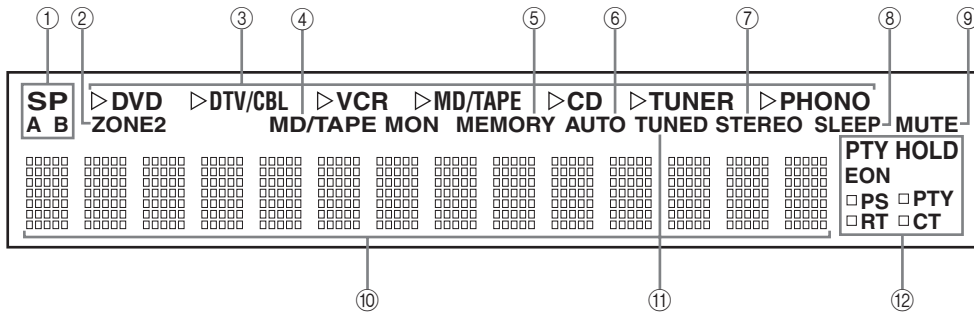

### ① SP (SPEAKERS) A/B indicators

Light up according to the set of speakers selected. Both indicators light up when both sets of speakers are selected.

### ② ZONE 2 indicator

Lights up when Zone 2 is turned on.

### ③ Input source indicators

Light up when this unit is in the corresponding mode.

### ④ MD/TAPE MON (MONITOR) indicator

Lights up while the MD/TAPE monitor function is turned on.

### ⑤ MEMORY indicator

Flashes for approximately 5 seconds after MEMORY on the front panel is pressed. While the MEMORY indicator is flashing, store the displayed station in the system memory by using A/B/C/D/E and one of the preset station number buttons on the front panel.

### ⑥ AUTO indicator

Lights up when this unit is in the automatic tuning mode.

### ⑦ STEREO indicator

Lights up when this unit is receiving a strong signal for an FM stereo broadcast while the AUTO indicator is lit.

### ⑧ SLEEP indicator

Lights up when the sleep timer is turned on.

### ⑨ MUTE indicator

Flashes while the MUTE function is turned on.

### ⑩ Multi-information display

Shows information when adjusting or changing settings.

### ⑪ TUNED indicator

Lights up when this unit is tuned into a station.

## ■ Europe model only

### ⑫ Radio Data System indicators

The box-shaped indicator beside the name of each Radio Data System mode lights up when the corresponding Radio Data System mode is selected.

#### PTY HOLD indicator

Lights up while searching for stations in the PTY SEEK mode.

#### EON indicator

Lights up when the Radio Data System station that offers the EON data service is being received.

## Rear panel

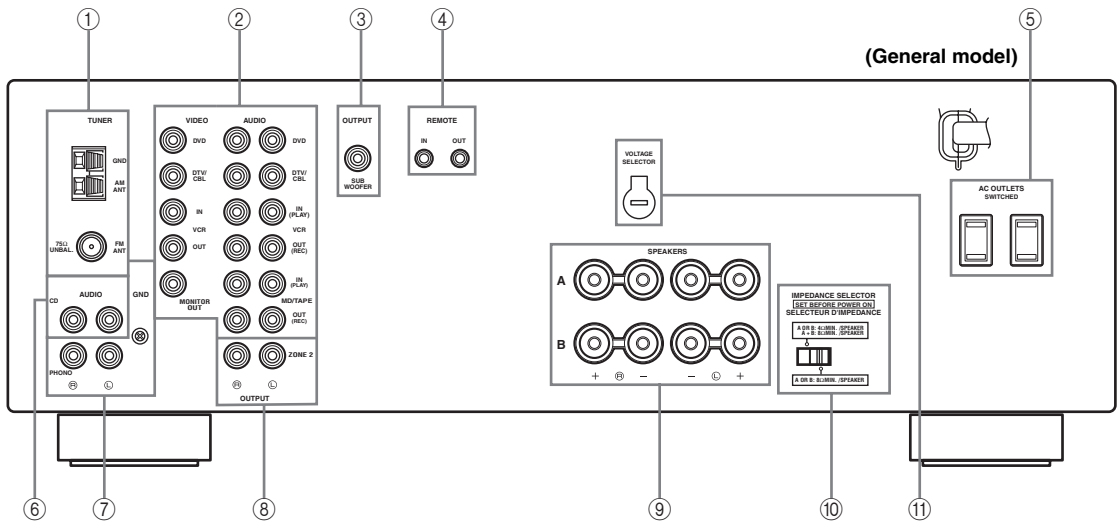

① **Antenna terminals**

Connect FM and AM antennas.  
See page 12 for connections information.

② **AUDIO/VIDEO jacks**

Connect audio and video components.  
See page 10 for connection information.

③ **SUB WOOFER OUTPUT jack**

Connect a subwoofer with built-in amplifier.

④ **REMOTE jacks**

These jacks are used to input/output remote control signals.  
See page 31 for connection information.

⑤ **AC OUTLET(S) (SWITCHED)**

Use to supply power to your other audio and video components.  
See page 14 for details.

⑥ **CD jacks**

Connect a CD player.  
See page 10 for connection information.

⑦ **PHONO jacks and GND terminal**

Connect a turntable.  
See page 10 for connection information.

⑧ **ZONE 2 jacks**

Connect a Zone 2 component.  
See page 31 for connection information.

⑨ **SPEAKERS terminals**

Connect speakers.  
See page 11 for connection information.

⑩ **IMPEDANCE SELECTOR switch**

Switches the impedance setting.  
See page 11 for details.

■ **Asia and General models only**

⑪ **VOLTAGE SELECTOR**

VOLTAGE SELECTOR on the rear panel of this unit must be set for your local main voltage BEFORE plugging the power supply cord into the AC wall outlet.  
Voltages are as follows:

Asia model ..... AC 220/230–240 V, 50/60 Hz  
General model..... AC 110/120/220/230–240 V, 50/60 Hz

## Remote control

This section describes the function of each button on the remote control used to control this unit or other components made by YAMAHA or other manufacturers. The functions of the buttons used to control your other audio and video components are the same as those of the corresponding buttons on those components. Refer to those components' instruction manuals for details. To operate other components using this remote control, see "REMOTE CONTROL FEATURES" on page 33.

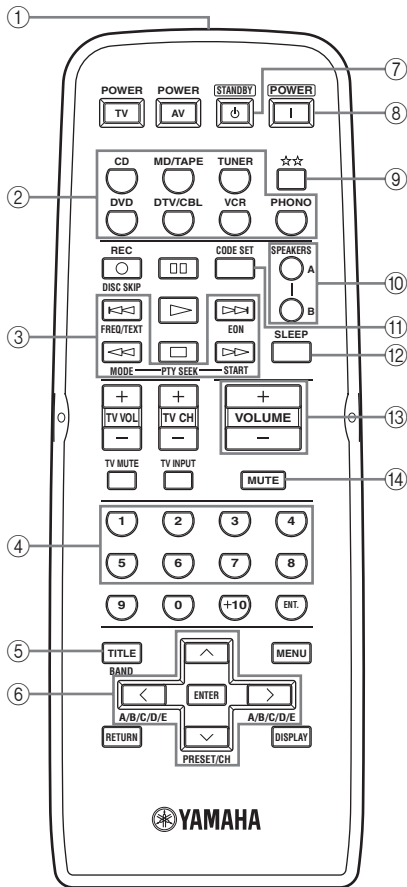

(Europe model)

### ① Infrared signal transmitter

Sends infrared signals.

### ② Input selector buttons

Select the desired input source and change the control area (see page 33).

### ③ Radio Data System control buttons

Controls the Radio Data System features.

#### Note

The Radio Data System features (FREQ/TEXT, EON, PTY SEEK MODE and PTY SEEK START) are only applicable to the Europe model and are operational only when TUNER is selected as the input source. For details, see "Receiving Radio Data System stations" on page 26.

### ④ Numeric buttons (1 to 8)

Select the preset station number (1 to 8) when TUNER is selected as the input source.

### ⑤ BAND

Switches to the previously used reception band (FM or AM) when TUNER is selected as the input source.

#### Note

The frequency of the previously received station is automatically recalled.

### ⑥ A/B/C/D/E </>

Selects the preset station group (A to E) when TUNER is selected as the input source (see page 25).

#### PRESET/CH ^ / v

Selects the preset station number (1 to 8) when TUNER is selected as the input source (see page 25).

### ⑦ STANDBY

Sets this unit to the standby mode.

#### Notes

- This button is operational only when MASTER ON/OFF on the front panel is pressed inward to the ON position.
- In the standby mode, this unit consumes a small amount of power to receive infrared signals from the remote control.
- This button does not set Zone 2 to the standby mode.

### ⑧ POWER

Turns on this unit.

#### Notes

- This button is operational only when MASTER ON/OFF on the front panel is pressed inward to the ON position.
- This button does not turn on Zone 2.

**⑨ ☆☆**

Changes the control area (see page 33).

**⑩ SPEAKERS A/B**

Turns on or off the set of speakers connected to the SPEAKERS A and/or SPEAKERS B terminals on the rear panel of this unit when the corresponding button is pressed each time.

**⑪ CODE SET**

Use to set up remote control codes (see page 35).

**⑫ SLEEP**

Sets the sleep timer.

**⑬ VOLUME +/-**

Increases or decreases the sound output level.

**Notes**

- This does not affect the OUT (REC) level.
- When you press VOLUME +/- to control the sound output level of this unit, VOLUME on the front panel rotates.

**⑭ MUTE**

Mutes the sound output. Press again to restore the sound output to the previous volume level (see page 19).

**Note**

The sound output to Zone 2 is not muted.

## Installing batteries in the remote control

### ■ Notes on batteries

- Change all of the batteries if the operation range of the remote control decreases.
- Use AA, R6, UM-3 batteries for the remote control.
- Make sure that the polarities are correct. See the illustration inside the battery compartment of each remote control.
- Remove the batteries if the remote control is not used for an extended period of time.
- Do not use old batteries together with new ones.
- Do not use different types of batteries (such as alkaline and manganese batteries) together. Read the packaging carefully as these different types of batteries may have the same shape and color.
- We strongly recommend using alkaline batteries.
- If the batteries have leaked, dispose of them immediately. Avoid touching the leaked material or letting it come into contact with clothing, etc. Clean the battery compartment thoroughly before installing new batteries.
- Do not throw away batteries with general house waste; dispose of them correctly in accordance with your local regulations.

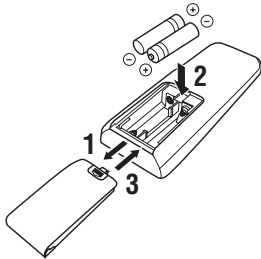

- 1** Open the battery compartment cover.
- 2** Insert the supplied batteries in each remote control according to the polarity markings (+ and -) on the inside of the battery compartment.
- 3** Close the cover back.

## Using the remote control

The remote control transmit a directional infrared beam.

Be sure to aim the remote control directly at the remote control sensor on the front panel of this unit or on the infrared signal receiver in Zone 2 during operation.

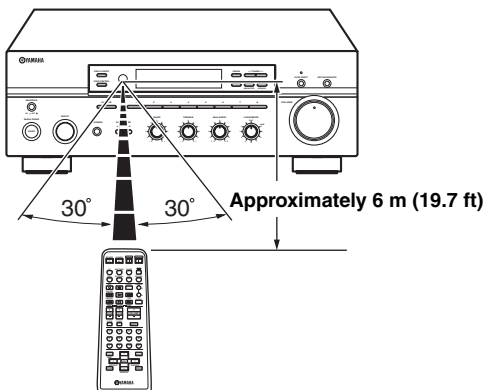

### ■ Handling the remote control

- The area between the remote control and this unit (or the infrared signal receiver in Zone 2) must be clear of large obstacles.
- Do not spill water or other liquids on the remote control.
- Do not drop the remote control.
- Do not leave or store the remote control in the following types of conditions:
  - places of high humidity, such as near a bath
  - places of high temperature, such as near a heater or a stove
  - places of extremely low temperatures
  - dusty places
- Do not expose the remote control sensor to strong lighting, in particular, an inverter type fluorescent lamp; otherwise, the remote control may not work properly. If necessary, position this unit away from direct lighting.

# CONNECTIONS

## CAUTION

- Do not connect this unit or other components to the main power until all connections between components are complete.
- Do not let the bare speaker wires touch each other or do not let them touch any metal part of this unit. This could damage this unit and/or the speakers.
- All connections must be correct: L (left) to L, R (right) to R, “+” to “+” and “-” to “-”. If the connections are faulty, no sound will be heard from the speakers, and if the polarity of the speaker connections is incorrect, the sound will be unnatural and lack bass. Also, refer to the owner’s manual for each of your components.
- Use the RCA type pin plug cables for audio and video components except speakers.



- The PHONO jacks are designed to connect a turntable with an MM or high-output MC cartridge. If you have a turntable with a low-output MC cartridge, use an in-line boosting transformer or an MC-head amplifier when connecting your turntable to the PHONO jacks.
- Connect your turntable to the GND terminal to reduce noise in the signal. However, you may hear less noise without the connection to the GND terminal for some record players.

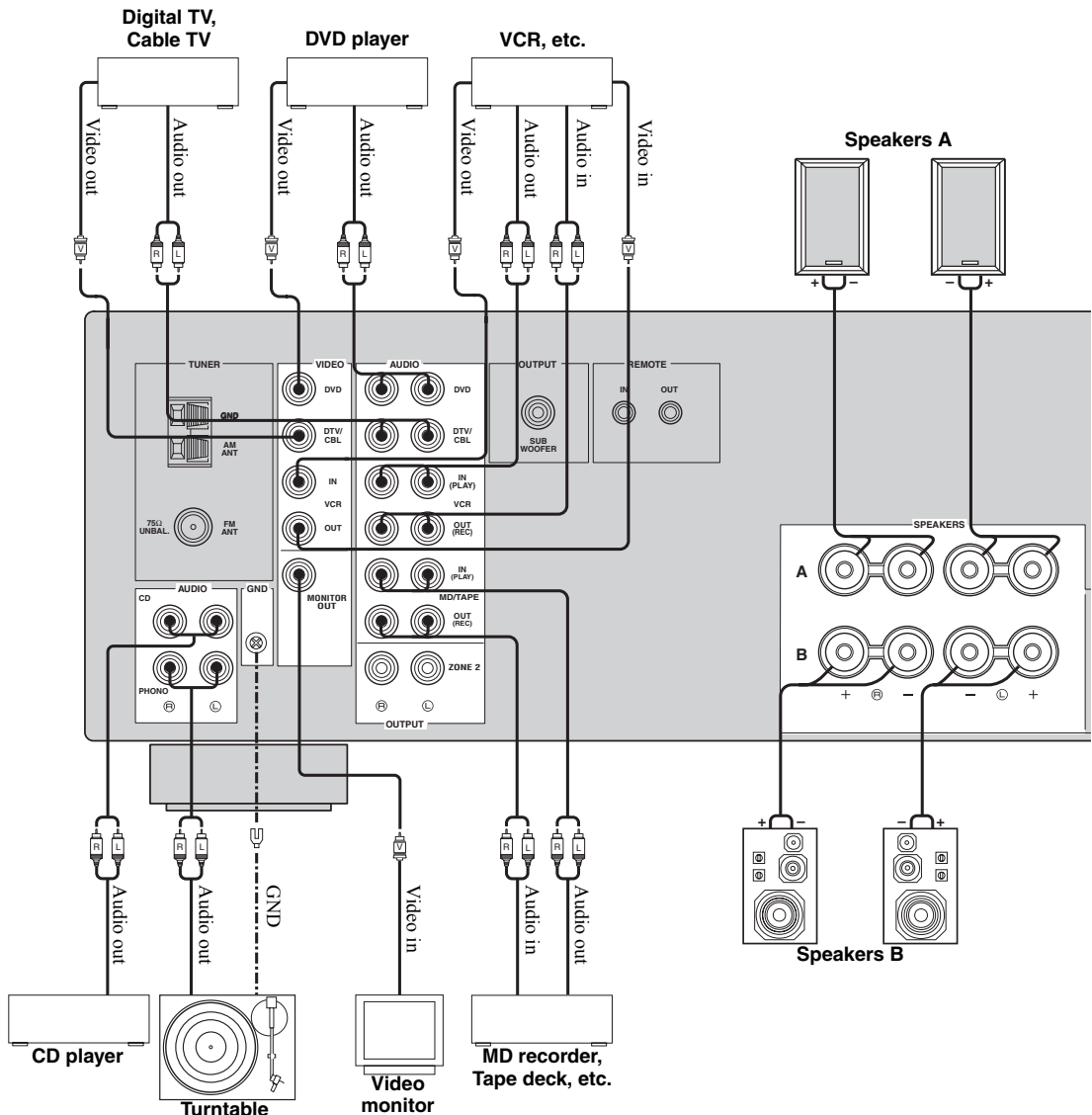

## Connecting speakers

- 1 Remove approximately 10 mm (3/8 in) of insulation from the end of each speaker cable and twist the exposed wires of the cable together to prevent short circuits.

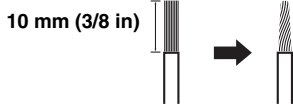

- 2 Unscrew the knob.

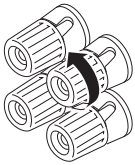

Red: positive (+)  
Black: negative (-)

- 3 Insert one bare wire into the hole in the side of each terminal.

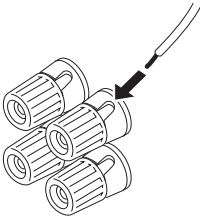

Red: positive (+)  
Black: negative (-)

- 4 Tighten the knob to secure the wire.

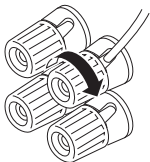

Red: positive (+)  
Black: negative (-)

### ■ Connecting the banana plug (U.S.A., Canada, Australia and General models only)

First, tighten the knob and then insert the banana plug into the end of the corresponding terminal.

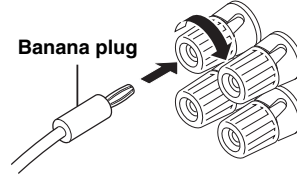

#### Notes

- One or two speaker sets can be connected to this unit. If you use only one speaker set, connect it to either the SPEAKERS A or B terminals.
- Use speakers with the specified impedance shown on the rear panel of this unit.

### ■ IMPEDANCE SELECTOR

#### CAUTION

Do not slide the IMPEDANCE SELECTOR switch while the power of this unit is turned on, as doing so may damage the unit.

Select the switch position (left or right) according to the impedance of the speakers in your system.

Switch position	Impedance level
Right	If you use one set (A or B), the impedance of each speaker must be 8 Ω or higher.
	If you use two sets (A and B), the impedance of each speaker must be 16 Ω or higher.
Left	If you use one set (A or B), the impedance of each speaker must be 4 Ω or higher.
	If you use two sets (A and B), the impedance of each speaker must be 8 Ω or higher.

#### Notes

- The Canada model cannot use two speaker sets (A and B) simultaneously when the IMPEDANCE SELECTOR switch is slid to the right position.
- If this unit fails to turn on, the IMPEDANCE SELECTOR switch may not be fully slid to either position. If this is the case, slide the switch all the way to either position when the power supply to this unit is completely cut off.

## Connecting the AM and FM antennas

Both AM and FM indoor antennas are included with this unit. In general, these antennas should provide sufficient signal strength. Connect each antenna correctly to the designated terminals.

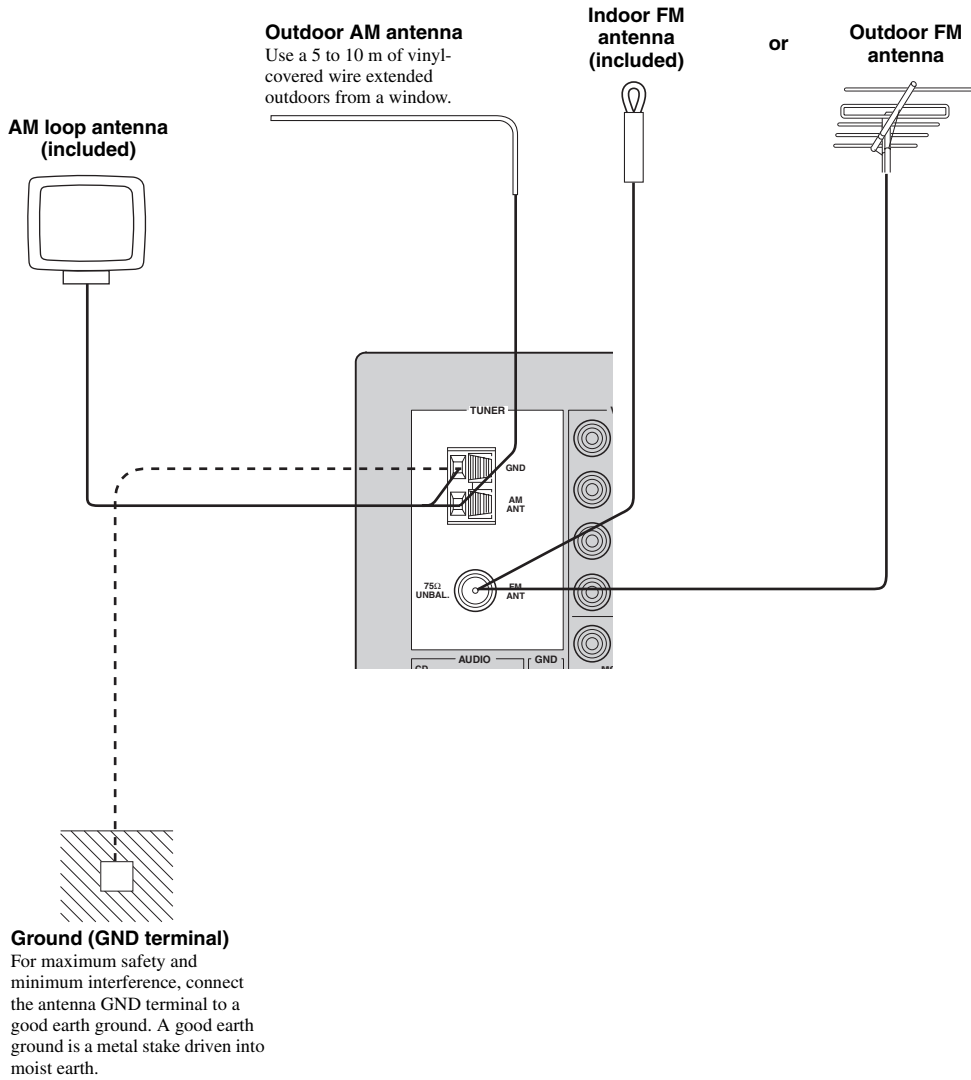

### Notes

- A properly installed outdoor antenna provides clearer reception than an indoor one. If you experience poor reception quality, an outdoor antenna may improve the quality. Consult your nearest authorized YAMAHA dealer or service center about outdoor antennas.
- If you connect an outdoor FM antenna to this unit, do not connect the indoor FM antenna to this unit.
- To minimize interference from automobile ignition, locate the antenna as far from heavy traffic as possible.
- Keep the feeder cable or coaxial cable as short as possible. Do not bundle or roll up excess cable.
- The antenna should be placed at least 2 meters from reinforced concrete walls or metal structures.

■ Connecting the AM loop antenna

1 Set up the AM loop antenna.

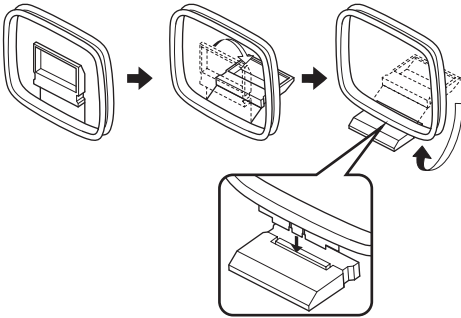

2 Press and hold the tab.

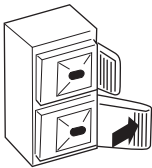

3 Insert the AM loop antenna lead wires into the AM ANT terminal.

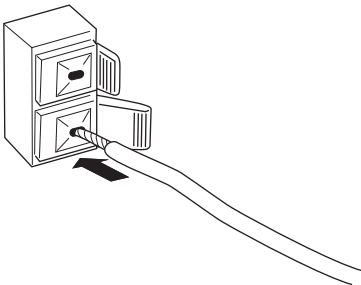

4 Release the tab.

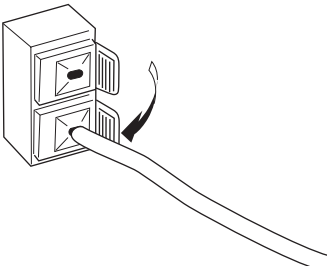

5 Repeat steps 2 to 4 to insert the AM loop antenna lead wires into the GND terminal.

6 Orient the AM loop antenna for the best reception.

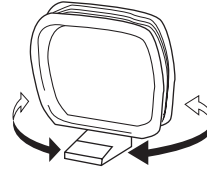

**Notes**

- The AM loop antenna should be placed away from this unit.
- A properly installed outdoor antenna provides clearer reception than an indoor one. If you experience poor reception quality, an outdoor antenna may improve the quality. It is recommended that you should connect a 5 to 10 m of vinyl-covered wire to the AM ANT terminal and extend it outdoors from a window. Consult your nearest authorized YAMAHA dealer or service center about outdoor antennas.
- The AM loop antenna should always be connected, even if an outdoor AM antenna is connected to this unit.

## Connecting the power supply cord

Plug the power supply cord into the AC wall outlet after all other connections are complete.

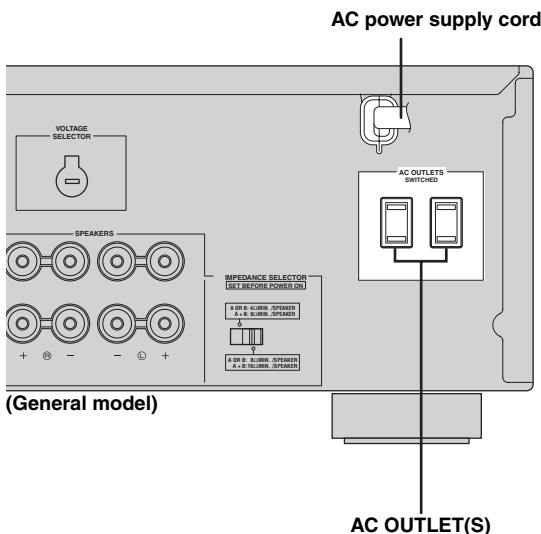

### ■ AC OUTLET(S) (SWITCHED)

Australia model ..... 1 outlet  
 Other models ..... 2 outlets

Use these outlets to connect the power supply cords from your other components to this unit. The outlets supply power to any connected components whenever the power of this unit is turned on. For information on the maximum power (total power consumption of components), see “SPECIFICATIONS” on page 39.

## Turning on and off this unit

When all connections are complete, turn on the power of this unit.

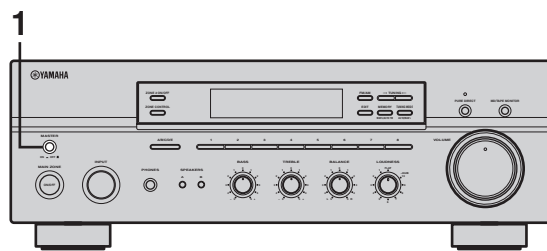

**1 Press MASTER ON/OFF on the front panel inward to the ON position to turn on the power of this unit.**

Main Zone of this unit turns on.



- You can set Main Zone of this unit to the standby mode by pressing MAIN ZONE ON/OFF on the front panel or STANDBY on the remote control. Press MAIN ZONE ON/OFF on the front panel or POWER on the remote control to turn Main Zone on again.
- Press MASTER ON/OFF on the front panel again to release it outward to the OFF position to turn off this unit.



While MASTER ON/OFF on the front panel is pressed inward to the ON position, you can turn on Zone 2 or set it to the standby mode independently (see page 32).

# PLAYING AND RECORDING

## CAUTION

Extreme caution should be exercised when you play back CDs encoded in DTS.

If you play back a CD encoded in DTS on a DTS-incompatible CD player, you will only hear some unwanted noise that may damage your speakers. Check whether your CD player supports CDs encoded in DTS. Also, check the sound output level of your CD player before you play back a CD encoded in DTS.

## Playing a source

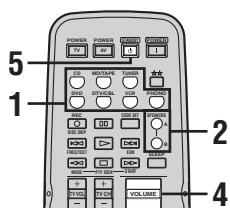
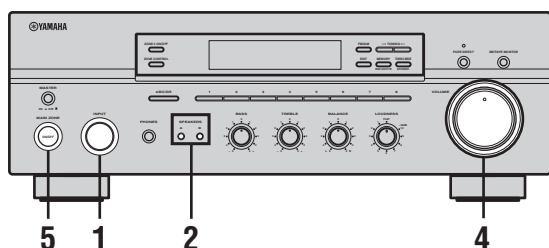

- 1 Rotate the **INPUT** selector on the front panel (or press one of the input selector buttons on the remote control) to select the desired input source.

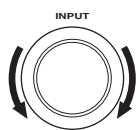

Front panel

or



Remote control

- 2 Press **SPEAKERS A** and/or **SPEAKERS B** on the front panel or on the remote control to select speakers A and/or speakers B.

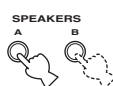

Front panel

or



Remote control

## Notes

- Both **SPEAKERS A** and **B** can be selected.
- Make sure that the **IMPEDANCE SELECTOR** switch is correctly set (see page 11).

- 3 Play the source.

- 4 Rotate **VOLUME** on the front panel (or press **VOLUME +/-** on the remote control) to adjust the sound output level.

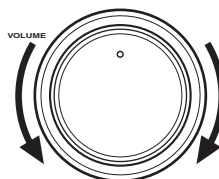

Front panel

or

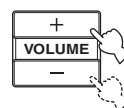

Remote control

- 5 Press **MAIN ZONE ON/OFF** on the front panel again (or press **STANDBY** on the remote control) to finish using this unit and set it to the standby mode.



Front panel

or



Remote control

## Adjusting the tonal quality

### ■ Adjusting the BALANCE control

Adjusts the sound output balance of the left and right speakers to compensate for sound imbalance caused by speaker locations or listening room conditions.

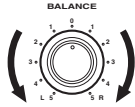

### ■ Using the PURE DIRECT button

Routes input signals from your audio sources so that the input signals bypass the BASS, TREBLE, BALANCE and LOUDNESS controls, thus eliminating any alterations to the audio signals and creating the purest possible sound.



### ■ Adjusting the BASS and TREBLE controls

Adjust the high and low frequency response.

#### BASS

Increases or decreases the low frequency response.

#### TREBLE

Increases or decreases the high frequency response.

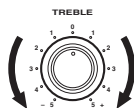
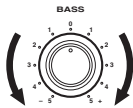

### ■ Adjusting the LOUDNESS control

Retains a full tonal range at any volume level, thus compensating for the human ears' loss of sensitivity to high and low-frequency ranges at a low volume level.

#### CAUTION

If the PURE DIRECT button is turned on with the LOUDNESS control set at a certain level, the input signals bypass the LOUDNESS control, resulting in a sudden increase in the sound output level. To prevent your ears or the speakers from being undesirably damaged, be sure to press the PURE DIRECT button after lowering the sound output level or after checking that the LOUDNESS control is properly set.

- 1 Rotate the LOUDNESS control on the front panel to the FLAT position.

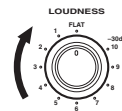

- 2 Rotate VOLUME on the front panel (or press VOLUME +/- on the remote control) to set the sound output level to the loudest listening level that you would listen to.

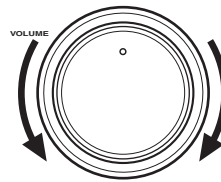

Front panel

or



Remote control

- 3 Rotate the LOUDNESS control until the desired volume is obtained.

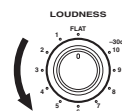



## Using the sleep timer

Use this feature to automatically set this unit to the standby mode after a certain amount of time. The sleep timer is useful when you are going to sleep while this unit is playing or recording a source. The sleep timer also automatically turns off any external components connected to the AC OUTLET(S).

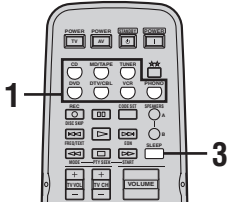

### Notes

- The sleep timer can only be set with the remote control.
- The sleep timer automatically turns off Zone 2. However, the power of Zone 2 components are not turned off.

- 1 Press one of the input selector buttons on the remote control to select an input source.**



- 2 Start playback on the selected input source.**

- 3 Press SLEEP repeatedly to set the amount of time before this unit is set to the standby mode.**

Each time you press SLEEP, the front panel display changes as shown below.

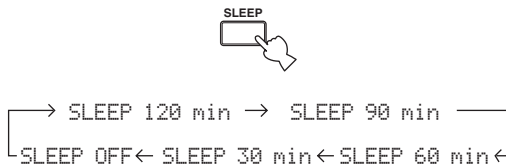

The SLEEP indicator flashes while switching the amount of time for the sleep timer.

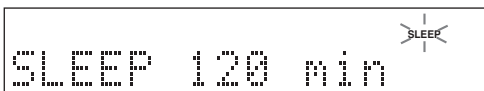

- 4 Press SLEEP repeatedly so that SLEEP OFF appears in the front panel display.**



After a few seconds, SLEEP OFF disappears from the front panel display, and the SLEEP indicator turns off.



The sleep timer setting can also be canceled by pressing **STANDBY** on the remote control (or **MAIN ZONE ON/OFF** or **MASTER ON/OFF** on the front panel) to set this unit to the standby mode.

## Muting the sound output

### 1 Press MUTE on the remote control to mute the sound output.

The MUTE indicator flashes in the front panel display.



After a few seconds, MUTE ON disappears from the front panel display.

### 2 Press MUTE on the remote control again to resume the sound output.

The MUTE indicator disappears from the front panel display.



# FM/AM TUNING

There are 2 tuning methods; automatic and manual. Select either method according to your preference and the strength of station signals.

## Automatic tuning

Automatic tuning is effective when station signals are strong and there is no interference.

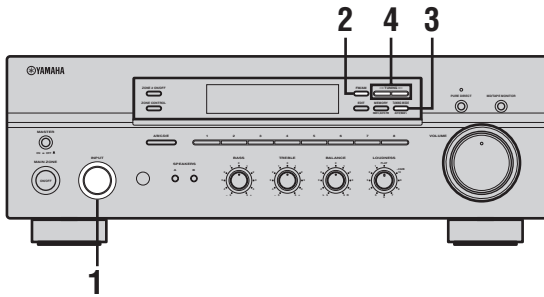

- 1 Rotate the INPUT selector (or press TUNER on the remote control) to select TUNER as the input source.

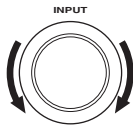

Front panel

or



Remote control

- 2 Press FM/AM on the front panel to select the reception band (FM or AM).

FM or AM appears in the front panel display.



- 3 Press TUNING MODE on the front panel so that the AUTO indicator lights up in the front panel display.



**AUTO**  
Lights up

- 4 Press TUNING </> once to begin automatic tuning.

Press > to tune into a higher frequency.

Press < to tune into a lower frequency.

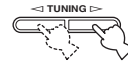

### Notes

- When you tune into a station, the frequency of the received station is shown in the front panel display.
- To search for another station, press TUNING </> once more.
- If the tuning search does not stop at the desired station because the station signals are weak, try using the manual tuning method.

## Manual tuning

Manual tuning is effective when station signals are weak.

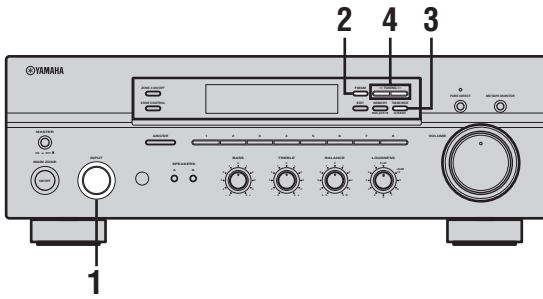

- 1 Rotate the INPUT selector (or press TUNER on the remote control) to select TUNER as the input source.

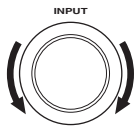

Front panel

or



Remote control

- 2 Press FM/AM on the front panel to select the reception band (FM or AM).

FM or AM appears in the front panel display.



- 3 Press TUNING MODE on the front panel so that the AUTO indicator disappears from the front panel display.



**AUTO**  
Disappears

- 4 Press TUNING  $\triangleleft$  /  $\triangleright$  to manually tune into the desired station.

Hold down the button to continue tuning search.

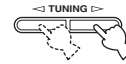

### Notes

- When you tune into a station, the frequency of the received station is shown in the front panel display.
- If you tune into an FM station, it is automatically received in the monaural mode to increase signal quality.

## Automatic preset tuning

You can use the automatic preset tuning method to automatically store FM stations. This function enables this unit to automatically tune into FM stations with strong signals and store up to 40 (8 stations in each of the 5 groups, A1 to E8) of those received stations in order. You can then easily recall any preset stations by selecting the preset station numbers where they are stored.

### Notes

- Any station data stored under a preset station number is cleared when you store a new station under that preset station number.
- If the number of received stations does not reach 40 (E8), automatic preset tuning automatically stops once searching all available stations are tuned into and stored.
- Only FM stations with sufficient signal strength are stored automatically by automatic preset tuning. If the station you want to store is weak in signal strength, try using the manual preset tuning method.

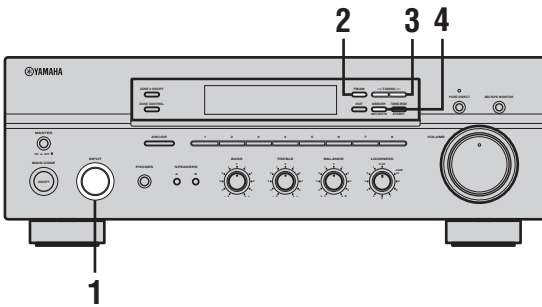

- 1 Rotate the INPUT selector (or press TUNER on the remote control) to select TUNER.

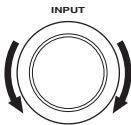

Front panel

or



Remote control

- 2 Press FM/AM on the front panel to select FM as the reception band.

FM appears in the front panel display.



- 3 Press and hold MEMORY on the front panel for more than 3 seconds.

The preset station group and the MEMORY and AUTO indicators flash in the front panel display.



- 4 Press TUNING </> once to begin automatic preset tuning.

Press > to tune into higher frequencies.

Press < to tune into lower frequencies.

When automatic preset tuning is complete, the frequency of the last preset station is shown in the front panel display.

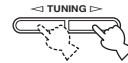

### Notes

- If TUNING </> is not pressed within approximately 5 seconds while the MEMORY and AUTO indicators are flashing, automatic preset tuning automatically begins from the currently displayed frequency and proceeds toward higher frequencies.
- Received stations are sequentially programmed to 8 stations in each preset station group. If 8 stations are all programmed in a preset station group, another 8 stations are sequentially programmed in the next preset station group.

## ■ Customized automatic preset tuning

You can specify a preset station group and a preset station number from which this unit stores the FM stations received by automatic preset tuning.

### 1 Press and hold MEMORY on the front panel for more than 3 seconds.



### 2 Press A/B/C/D/E and then press one of the preset station number buttons on the front panel to select the preset station group and the preset station number where the first received station will be stored.

For example, if you select C5, the first received station is automatically programmed to C5 and the next received stations are sequentially programmed to C6, C7, etc.

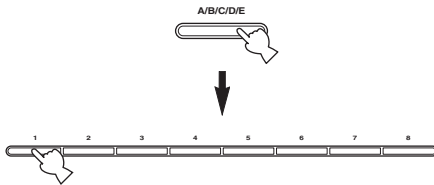

### 3 Press TUNING </> on the front panel to begin automatic preset tuning.

Press > to tune into higher frequencies.

Press < to tune into lower frequencies.

When automatic preset tuning is complete, the frequency of the last preset station is shown in the front panel display.

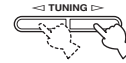

#### Note

Automatic preset tuning stops when the received stations have all been stored up to E8.

## Manual preset tuning

You can also manually store up to 40 stations (8 stations in each of the 5 groups, A1 to E8). You can then easily recall any preset stations by selecting the preset station numbers where they are stored.

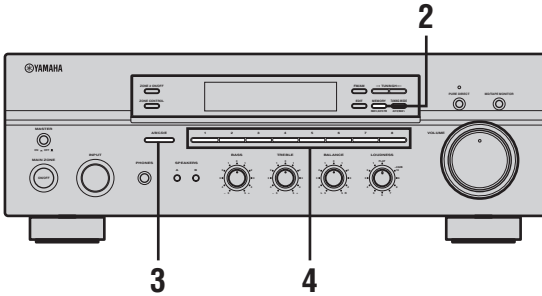

**1 Repeat steps 1 to 4 in “Automatic tuning” or in “Manual tuning” to tune into a station.**

When you tune into a station, the frequency of the received station is shown in the front panel display.

**2 Press MEMORY on the front panel.**

The MEMORY indicator flashes in the front panel display for approximately 5 seconds.



**MEMORY  
Flashes**

**3 Press A/B/C/D/E on the front panel repeatedly to select a preset station group (A to E).**

The selected preset station group is shown in the front panel display.

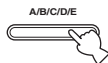

**4 Press one of the preset station number buttons on the front panel to select a preset station number (1 to 8) where you want to store the station.**

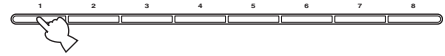

**Note**

This operation must be done within 5 seconds while the MEMORY indicator is flashing in the front panel display. Otherwise, the manual preset tuning process is automatically canceled.

**5 Press MEMORY on the front panel to store the station.**

**6 Repeat steps 1 to 5 to store other stations.**

**Notes**

- Any station data stored under a preset station number is cleared when you store a new station under that preset station number.
- The reception mode (stereo or monaural) is stored along with the station frequency.

## Selecting preset stations

You can tune into the desired station simply by selecting the preset station number where it is stored.

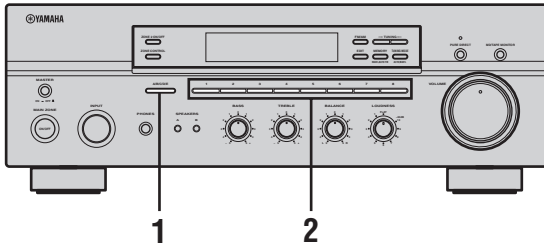

- 1 Press A/B/C/D/E on the front panel repeatedly (or press A/B/C/D/E </> on the remote control) to select a preset station group (A to E).

The selected preset station group is shown in the front panel display.

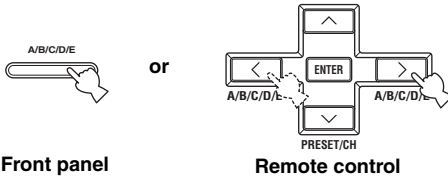

- 2 Press one of the preset station number buttons on the front panel (or PRESET </> on the remote control) to select a preset station number (1 to 8).

The preset station number appears in the front panel display along with the reception band and the frequency.

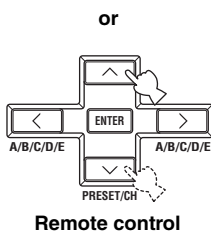
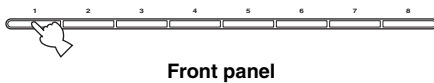

## Exchanging preset stations

You can exchange the assignment of two preset stations with each other. The following procedure describes an example where a preset station E1 is exchanged with another preset station A5.

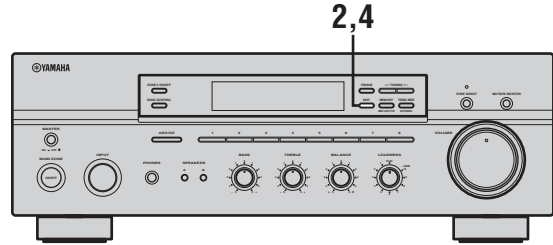

- 1 Repeat steps 1 and 2 in “Selecting preset stations” to select a preset station E1.

- 2 Press EDIT on the front panel. E1 and the MEMORY indicator flash in the front panel display.



- 3 Repeat steps 1 and 2 in “Selecting preset stations” to select another preset station A5. A5 and the MEMORY indicator flash in the front panel display.

MEMORY Flashes

- 4 Press EDIT on the front panel again.

E1-A5 appears in the front panel display, indicating that the two preset station assignments have been exchanged.



# RADIO DATA SYSTEM (EUROPE MODEL ONLY)

## Receiving Radio Data System stations

Radio Data System is a data transmission system used by FM stations in many countries. The Radio Data System function is carried out among the network stations.

This unit can receive various Radio Data System data such as PS (Program Service name), PTY (Program Type), RT (Radio Text), CT (Clock Time), EON (Enhanced Other Networks) when receiving Radio Data System broadcasting stations.

### ■ PS (Program Service name) mode

The name of the Radio Data System station being received is displayed.

### ■ PTY (Program Type) mode

There are 15 program types to classify Radio Data System stations.

NEWS	News
AFFAIRS	Current affairs
INFO	General information
SPORT	Sports
EDUCATE	Education
DRAMA	Drama
CULTURE	Culture
SCIENCE	Science
VARIED	Light entertainment
POP M	Pops
ROCK M	Rock
M.O.R. M	Middle-of-the-road music (easy-listening)
LIGHT M	Light classics
CLASSICS	Serious classics
OTHER M	Other music

### ■ RT (Radio Text) mode

Information about the program (such as the title of the song or name of the singer) on the Radio Data System station being received is displayed using a maximum of 64 alphanumeric characters, including the umlaut symbol. If other characters are used for RT data, they are displayed with an underbar (\_).

### ■ CT (Clock Time) mode

The current time is displayed and updated every minute. If the data are accidentally cut off, "CT WAIT" may appear.

### ■ EON (Enhanced Other Networks)

See "EON function" on page 28.

## Changing the Radio Data System mode

Four modes are available for displaying Radio Data System data. The PS, PTY, RT and/or CT indicators that correspond to the Radio Data System data services offered by the station light up in the front panel display.

- 1 Press **TUNER** on the remote control to set this unit to tuner mode.



- 2 Press **FREQ/TEXT** repeatedly on the remote control to display the various Radio Data System data offered by the transmitting station.

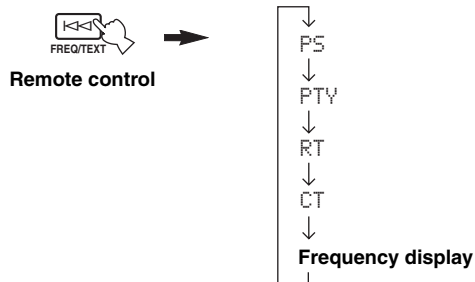

**Notes**

- Do not press **FREQ/TEXT** until a Radio Data System indicator lights up in the front panel display. You cannot change the mode if you press the button prior to this. This is because this unit has not finished receiving all of the Radio Data System data from the station.
- Radio Data System data not offered by the station cannot be selected.
- This unit cannot utilize the Radio Data System data source if the signal received is not strong enough. In particular, the RT mode requires a large amount of data, so it is possible that the RT mode may not be displayed even if other Radio Data System modes (PS, PTY, etc.) are displayed.
- Radio Data System data may not be received under poor reception conditions. In such cases, press **TUNING MODE (AUTO/MAN'L MONO)** so that the **AUTO** indicator disappears from the front panel display. Although this will change the reception mode to manual, Radio Data System data may be displayed when you change the display to Radio Data System mode.
- If the signal strength is weakened by external interference during the reception of a Radio Data System station, the Radio Data System data service may be cut off suddenly and "...WAIT" will appear in the front panel display.

**PTY SEEK function**

If you select the desired program type, this unit automatically searches all preset Radio Data System stations that are broadcasting a program of the required type.

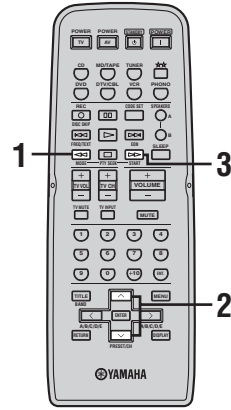

When performing this operation with the remote control, first press **TUNER** to set the remote to tuner mode.

**1 Press PTY SEEK MODE on the remote control to set this unit in the PTY SEEK mode.**

The program type of the station being received or "NEWS" flashes in the front panel display.

To exit from the PTY SEEK mode, press **PTY SEEK MODE** again.

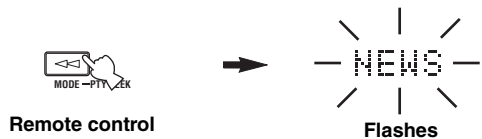

BASIC OPERATION

English

**2 Press PRESET/CH ^ / v on the remote control to select the desired program type.**

The selected program type appears in the front panel display.

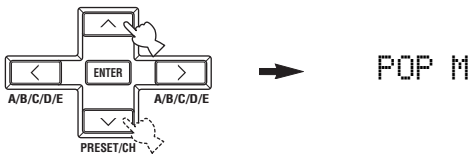

**3 Press PTY SEEK START on the remote control to begin searching all preset Radio Data System stations.**

The selected program type flashes and the PTY HOLD indicator lights up in the front panel display while searching for stations.

To cancel searching, press PTY SEEK START again.



- The unit stops searching when it finds a station broadcasting the selected type of program.
- If the found station is not the one you desire, press PTY SEEK START again. This unit resumes searching for another station broadcasting the same type of program.

**EON function**

This function uses the EON data service on the Radio Data System station network. If you select the desired program type (NEWS, INFO, AFFAIRS or SPORT), this unit automatically searches for all preset Radio Data System stations that are scheduled to broadcast the selected type of program and switches from the station currently being received to the new station when the broadcast starts.

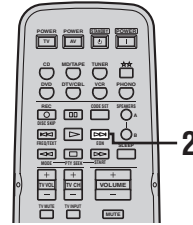

When performing this operation with the remote control, first press TUNER to set the remote to tuner mode.

**Note**

This function can only be used when a Radio Data System station that offers the EON data service is being received. When such a station is being received, the EON indicator lights up in the front panel display.

**1 Check that the EON indicator is lit in the front panel display.**

If the EON indicator is not lit up, tune into another Radio Data System station so that the EON indicator lights up.

**2 Press EON repeatedly on the remote control to select the desired program type (NEWS, INFO, AFFAIRS or SPORT).**

The selected program type name appears in the front panel display.



Remote control

- If a preset Radio Data System station type starts broadcasting the selected type of program, the unit automatically switches from the program being received to that program. (The EON indicator flashes.)
- When broadcasting of the selected program ends, the unit returns to the previous station (or another program on the same station).

**■ To cancel this function**

Press EON repeatedly until no program type name is shown in the front panel display.

# ADVANCED SETUP

## ■ ADVANCED SETUP menu parameters

Change the initial settings (indicated in bold under each parameter) to reflect the needs of your listening environment.

### Factory presets **PRESET**

Use to reset all parameters to the factory presets.

Choices: **CANCEL**, RESET

- Select **CANCEL** if you do not want the parameters of this unit to be initialized when you reset the factory presets.
- Select **RESET** if you want all of the parameters of this unit to be initialized when you reset the factory presets.

### Notes

- This setting does not affect the parameters in the ADVANCED SETUP menu.
- The resetting process starts next time you turn on the power of this unit.

### Remote **REMOTE**

Use to switch the remote control ID of this unit.

Choices: ID1, **ID2**

- Select ID1 to operate this unit using an alternative code.
- Select ID2 to operate this unit using the default code.

### Note

You must also make settings for the remote control (see page 30).

### Tuner **TU**

#### (Asia and General models only)

Use to switch the frequency step selection according to the frequency spacing in your area.

Choices: **AM10/FM100**, AM9/FM50

- North, Central and South America: AM10/FM100 (kHz)
- Other areas: AM9/FM50 (kHz)

## Changing the ADVANCED SETUP menu parameters

The ADVANCED SETUP menu is displayed in the front panel display.



- During the ADVANCED SETUP procedure, audio output is muted.
- During the ADVANCED SETUP procedure, only **MASTER ON/OFF**, **A/B/C/D/E** and the preset station number buttons (1 and 2) on the front panel are operational.

1,2,5

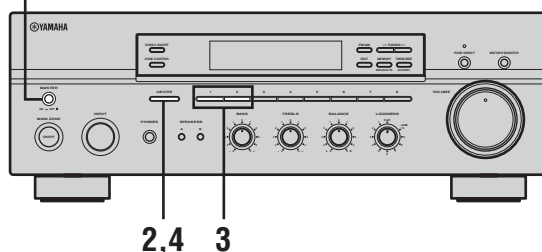

- 1 Press **MASTER ON/OFF** on the front panel to release it outward to the **OFF** position.



- 2 Press and hold **A/B/C/D/E** on the front panel and then press **MASTER ON/OFF** inward to the **ON** position.

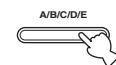

While holding down,  
press



- 3 Press the preset station number buttons (1 and 2) on the front panel repeatedly to move through the menu and select the parameter you want to adjust.**

See page 29 for a complete list of available parameters.



- 4 Press A/B/C/D/E on the front panel repeatedly to toggle between the available parameters.**

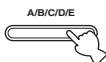

- 5 Press MASTER ON/OFF to release it outward to the OFF position to confirm your setting.**



**Note**

The settings you made are reflected next time you turn on the power of this unit.

## Switching the remote control ID

You can select the unit you want to operate with the remote control by switching the remote control ID.

- 1 Press and hold CODE SET on the remote control and then press TUNER on the remote control.**



- 2 While holding down CODE SET on the remote control, use the numeric buttons on the remote control to enter the three-digit code number listed in the table below.**

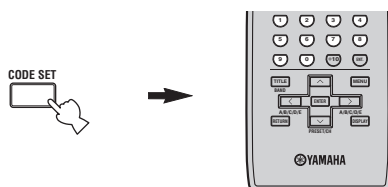

Remote control ID* (this unit's setting)	Function	Code number
ID1	To operate this unit using an alternative code.	801
ID2 (default setting)	To operate this unit using the default code.	802

\* When you change the remote control ID, you must switch the remote control ID of this unit (see page 29).

When using multiple YAMAHA receivers or amplifiers with the same default code setting, you may unwantedly operate those components simultaneously. In this case, set one of the alternative codes for this unit to operate this unit separately.

# ZONE 2

## Connecting the Zone 2 components

This unit allows you to configure a multi-room audio and video system. The Zone 2 feature enables you to set this unit to reproduce separate input sources in the main room and in Zone 2 (the second room) simultaneously. You can also control this unit from the second room using the Zone 2 remote control (sold separately).

You need the following additional equipment to use the multi-room system of this unit:

- Zone 2 remote control
- An infrared signal receiver for the second room
- An infrared emitter for the main room. This emitter transmits the infrared signals sent by the Zone 2 remote control in Zone 2 to the components in the main room.
- An amplifier and speakers for the second room



Some YAMAHA models are able to connect directly to the REMOTE OUT jack on the rear panel of this unit. If you own these products, you may not need to use an infrared emitter. Up to six YAMAHA components can be connected as shown below.

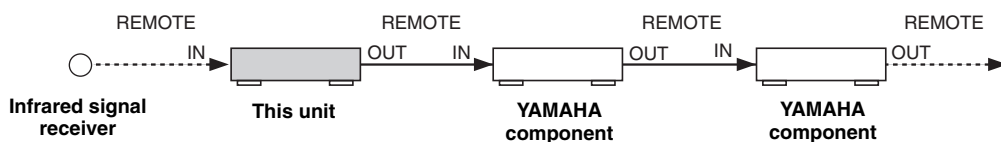

### ■ Multi-room configuration and connections

The following illustration shows an example of the multi-room system configuration and connections.

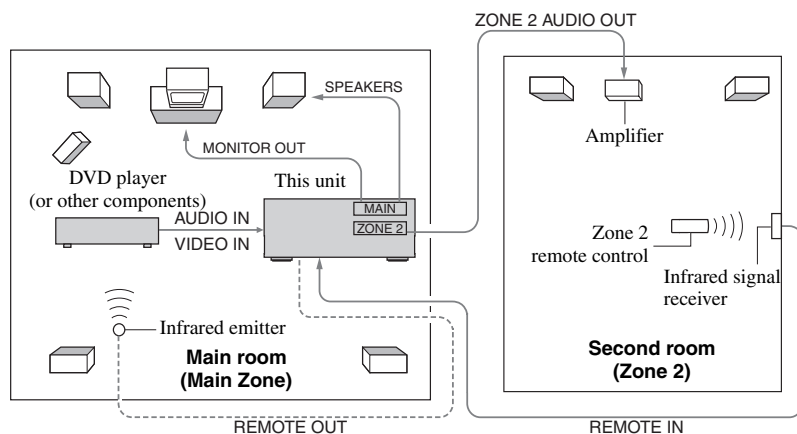

Since there are many possible ways to connect and use this unit in a multi-room configuration, we recommend that you consult with your nearest authorized YAMAHA dealer or service center for the Zone 2 connections that best meet your requirements.

## **Controlling Zone 2**

You can control the input source of Zone 2 independently of the listening conditions in the main room.

- 1 Press ZONE 2 ON/OFF on the front panel to turn on Zone 2.**



- 2 Press ZONE 2 CONTROL on the front panel**  
The ZONE 2 indicator flashes in the front panel display.



- 3 While the ZONE 2 indicator is flashing, rotate the INPUT selector on the front panel to select the input source of Zone 2.**

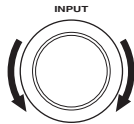

- You can also select the input source by using the Zone 2 remote control (sold separately). Press POWER on the Zone 2 remote control to turn on Zone 2, and then press one of the input selector buttons to select the input source.
- You can mute the sound output to Zone 2 by pressing MUTE on the ZONE 2 remote control. Press again to restore the sound output.

# REMOTE CONTROL FEATURES

## Control area

### ■ Controlling this unit

The shaded areas below can be used to control this unit.

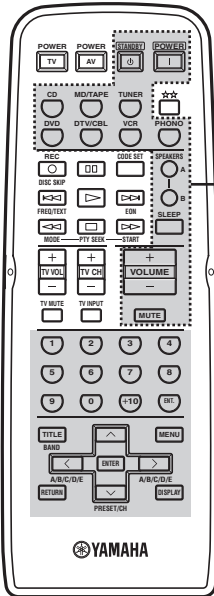

The buttons inside the dotted lines control this unit in any mode (POWER, STANDBY, SLEEP, the input selector buttons, VOLUME +/- and MUTE).

### ■ Controlling other components

The shaded areas below can be used to control other audio and video components made by YAMAHA and other manufacturers. Each button has a different function depending on the selected component. Select the component you want to control by pressing one of the input selector buttons. The name of the selected component appears in the front panel display.

The input selector buttons switch the function of the component control area below.

#### Component control area

You can control up to 7 different components by setting the appropriate remote control codes (see page 35).

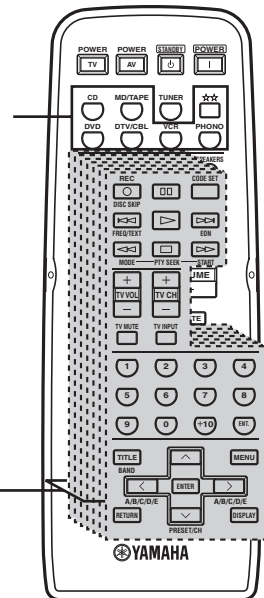

You can use the ☆☆ button to control other components regardless of whether they are connected to this unit.

## Controlling other components

In addition to controlling this unit, you can also control other audio and video components made by YAMAHA and other manufacturers using the supplied remote control. To control other components, you must set the appropriate remote control codes.

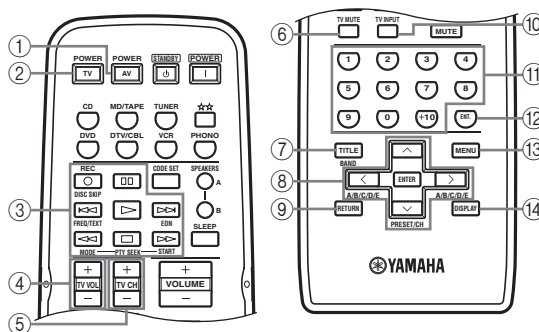

	DVD player	VCR	Digital TV/ Cable TV	TV	CD player	Tape deck	MD recorder	Tuner
① AV POWER	Power *1	Power *1	Power *1	VCR power	Power *1	Power *1	Power *1	Power *1
② TV POWER	TV power	TV power	TV power	Power *1	TV power	TV power	TV power	TV power
③ ◀◀	Search backward	Search backward	VCR search backward	VCR search backward	Search backward	Search backward	Search backward	PTY MODE *2
▶▶	Search forward	Search forward	VCR search forward	VCR search forward	Search forward	Search forward	Search forward	PTY START *2
◀◀	Skip backward				Skip backward	Direction A	Skip backward	FREQ/TEXT *2
▶▶	Skip forward				Skip forward	Direction B	Skip forward	EON *2
REC/ DISC SKIP	Disc skip	Rec	VCR rec	VCR rec	Disc skip	Rec	Rec	
□	Stop	Stop	VCR stop	VCR stop	Stop	Stop	Stop	
⏸	Pause	Pause	VCR pause	VCR pause	Pause	Deck A/B	Pause	
▷	Play	Play	VCR play	VCR play	Play	Play	Play	
④ TV VOL +	TV volume +	TV volume +	TV volume +	Volume +	TV volume +	TV volume +	TV volume +	TV volume +
TV VOL -	TV volume -	TV volume -	TV volume -	Volume -	TV volume -	TV volume -	TV volume -	TV volume -
⑤ TV CH +	TV channel +	Channel +	Channel +	Channel +	TV channel +	TV channel +	TV channel +	TV channel +
TV CH -	TV channel -	Channel -	Channel -	Channel -	TV channel -	TV channel -	TV channel -	TV channel -
⑥ TV MUTE	TV mute	TV mute	TV mute	Mute	TV mute	TV mute	TV mute	TV mute
⑦ TITLE	Title	Title	Title	Title				Band
⑧ ENTER	Menu enter		Menu select	Menu select				
PRESET/CH ^	Menu up		Menu up	Menu up				Preset up (1 to 8)
PRESET/CH v	Menu down		Menu down	Menu down				Preset down (1 to 8)
A/B/C/D/E <	Menu left		Menu left	Menu left				Preset down (A to E)
A/B/C/D/E >	Menu right		Menu right	Menu right				Preset up (A to E)
⑨ RETURN	Return	Return	Return	Return				
⑩ TV INPUT	TV input	TV input	TV input	Input	TV input	TV input	TV input	TV input
⑪ 1-9, 0, +10	Numeric buttons	Numeric buttons	Numeric buttons	Numeric buttons	Numeric buttons		Numeric buttons	Preset stations (1-8)
⑫ ENT.		Enter	Enter/recall	Enter/ numeric button			Index	
⑬ MENU	Menu		Menu	Menu				
⑭ DISPLAY	Display		Display	Display	Display		Display	

\*1 This button functions only when the original remote control of the component has the POWER button.

\*2 These buttons function for Europe model only.

## Setting remote control codes

You can control other components by setting the appropriate remote control codes. Codes can be set up for each input source. For a complete list of available remote control codes, refer to “LIST OF REMOTE CONTROL CODES” at the end of this manual.

The following table show the default component category (library) and the remote control code for each input source.

### Remote control code default settings

Input source	Default component category (library)	Manufacturer	Default YAMAHA code
CD	CD	YAMAHA	199
MD/TAPE	TAPE	YAMAHA	499
DVD	DVD	YAMAHA	699
DTV/CBL*	—	—	—
VCR	—	—	—
PHONO	—	—	—
☆☆	—	—	—

\* You can only set the TV remote control codes for the DTV/CBL button. However, other remote control codes can be set for any input selector buttons except DTV/CBL.

### Note

You may not be able to operate your other YAMAHA components even if the YAMAHA remote control code is initially set as listed above. In this case, try setting other YAMAHA remote control codes.

- 1 Press and hold CODE SET on the remote control and then press one of the input selector buttons on the remote control to select the input source you want to set up.



### Note

You must press and hold CODE SET throughout this operation.

- 2 While holding down CODE SET on the remote control, use the numeric buttons on the remote control to enter the three-digit remote control code for the selected input source.

When the setting succeeds, “PRESET OK” appears; however, when it does not, “PRESET NG” appears in the front panel display.

To reset the code, enter the default code for each input source listed in the remote control code default settings table.

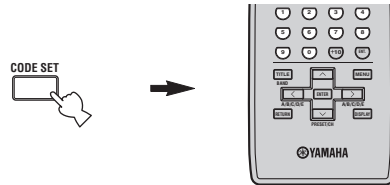

### Notes

- If the manufacturer of your component has more than one code, try setting each of them until you find the correct one.
- You can only assign one remote control code to each input selector button.

# TROUBLESHOOTING

Refer to the chart below if this unit does not function properly. If the problem you are experiencing is not listed below or if the instructions below do not help, set this unit to the standby mode, disconnect the power cord, and contact the nearest authorized YAMAHA dealer or service center.

## ■ General

Problem	Cause	Remedy	See page
<b>This unit fails to turn on.</b>	The power supply cord is not connected or the plug is not completely inserted.	Connect the power supply cord firmly.	—
	The impedance setting is incorrect.	Set the impedance to match your speakers.	11
	The protection circuitry has been activated because of a short circuit, etc.	Check that the speaker wires are not touching each other and then turn the power of this unit back on.	11
	The IMPEDANCE SELECTOR switch on the rear panel is not set to either end.	Set the IMPEDANCE SELECTOR switch to either end when the power of this unit is turned off.	11
	This unit has been exposed to a strong external electric shock (such as lightning or strong static electricity).	Set this unit to the standby mode, disconnect the power supply cord, plug it back in after 30 seconds, then use it normally.	—
<b>No sound</b>	Incorrect input or output cable connections.	Connect the cables properly. If the problem persists, the cables may be defective.	10
	No appropriate input source has been selected.	Select an appropriate input source with the INPUT selector on the front panel (or one of the input selector buttons on the remote control).	15
	The SPEAKERS A/B switches are not set properly.	Turn on the corresponding SPEAKERS A or SPEAKERS B.	15
	Speaker connections are not secure.	Secure the connections.	11
<b>The sound suddenly goes off.</b>	The protection circuitry has been activated because of a short circuit, etc.	Check that the IMPEDANCE SELECTOR setting is correct.	11
		Check that the speaker wires are not touching each other and then turn the power of this unit back on.	11
<b>Only the speaker on one side can be heard.</b>	Incorrect cable connections.	Connect the cables properly. If the problem persists, the cables may be defective.	10
	Incorrect setting for the BALANCE control.	Set the BALANCE control to the appropriate position.	16
<b>There is a lack of bass and no ambience.</b>	The + and – wires are connected in reverse at the amplifier or the speakers.	Connect the speaker wires to the correct + and – phase.	11
<b>A “humming” sound can be heard.</b>	Incorrect cable connections.	Connect the audio plugs firmly. If the problem persists, the cables may be defective.	10
	No connection from the turntable to the GND terminal.	Make the GND connection between the turntable and this unit.	10
<b>The volume level is low while playing a record.</b>	The record is being played on a turntable with an MC cartridge.	The turntable should be connected to this unit through the MC head amplifier.	—
<b>The volume level cannot be increased, or the sound is distorted.</b>	The component connected to the MD/TAPE OUT jacks of this unit is turned off.	Turn on the power of the component.	—

<b>The sound is degraded when listening with the headphones connected to the CD player or the tape deck connected to this unit.</b>	The power of this unit is turned off, or this unit is set to the standby mode.	Turn on the power of this unit.	14
<b>The sound level is low.</b>	The LOUDNESS control is functioning.	Set the LOUDNESS control to the FLAT position.	16
<b>Using the BASS, TREBLE, BALANCE and LOUDNESS controls does not affect the tonal quality.</b>	The PURE DIRECT button is turned on.	The PURE DIRECT button must be turned off to use those controls.	16

## ■ Tuner

Problem		Cause	Remedy	See page
FM	<b>FM stereo reception is noisy.</b>	The particular characteristics of the FM stereo broadcasts being received may cause this problem when the transmitter is too far away or the antenna input is poor.	Check the antenna connections. Try using a high-quality directional FM antenna.	12
			Try using the manual tuning method.	21
	<b>There is distortion, and clear reception cannot be obtained even with a good FM antenna.</b>	There is multipath interference.	Adjust the antenna position to eliminate the multipath interference.	—
	<b>The desired station cannot be tuned in with the automatic tuning method.</b>	The signal is too weak.	Try using a high-quality directional FM antenna.	12
			Try using the manual tuning method.	21
	<b>Previously preset stations can no longer be tuned in.</b>	This unit has been disconnected for a long period.	Preset the stations again.	22
AM	<b>The desired station cannot be tuned in with the automatic tuning method.</b>	The signal is weak or the antenna connections are loose.	Tighten the AM loop antenna connections and orient it for the best reception.	—
			Try using the manual tuning method.	21
	<b>There are continuous crackling and hissing noises.</b>	The noises may result from lightning, fluorescent lamps, motors, thermostats or other electrical equipment.	Try using an outdoor antenna and a ground wire. This will help somewhat, but it is difficult to eliminate all noise.	—
	<b>There are buzzing and whining noises.</b>	A TV set is being used nearby.	Move this unit away from the TV set.	—

## ■ Remote control

Problem	Cause	Remedy	See page
<b>The remote control does not work nor function properly.</b>	Wrong distance or angle.	The remote control will function within a maximum range of 6 m (19.7 ft) and no more than 30 degrees off-axis from the front panel.	9
	Direct sunlight or lighting (from an inverter type of fluorescent lamp, etc.) is striking the remote control sensor of this unit.	Reposition this unit.	—
	The batteries are weak.	Replace all batteries.	9
	The remote control ID and this unit's ID do not match.	Switch the remote control ID or this unit's ID.	29, 30
	The remote control code was not correctly set.	Try setting another code of the same manufacturer using "LIST OF REMOTE CONTROL CODES" at the end of this manual.	35
	Even if the remote control code is correctly set, there are some models that do not respond to the remote control.	Use the supplied remote control for the components.	—

# SPECIFICATIONS

## AUDIO SECTION

- Minimum RMS Output Power  
(8 Ω, 20 Hz to 20 kHz, 0.04% THD) ..... 75 W + 75 W
- Dynamic Power (IHF)  
(8/6/4/2 Ω) ..... 105/125/150/178 W
- Maximum Output Power [Europe model only]  
(1 kHz, 0.7% THD, 4 Ω) ..... 105 W
- IEC Output Power [Europe model only]  
(1 kHz, 0.04% THD, 8 Ω) ..... 84 W
- Power Band Width  
(0.08% THD, 35 W, 8 Ω) ..... 10 Hz to 50 kHz
- Damping Factor (SPEAKERS A)  
20 Hz to 20 kHz, 8 Ω ..... 150 or more
- Maximum Output Power (EIAJ)  
[Asia and General models only]  
(1 kHz, 10% THD, 8 Ω) ..... 115 W
- Maximum Input Signal  
PHONO (1 kHz, 0.04% THD) ..... 70 mV or more  
CD, etc. (1 kHz, 0.04% THD) ..... 2.2 V or more
- Frequency Response  
CD, etc. (20 Hz to 20 kHz) ..... 0 ± 0.5 dB  
CD, etc. PURE DIRECT ON (10 Hz to 100 kHz) ..... 0 ± 1.0 dB
- RIAA Equalization Deviation  
PHONO ..... ± 0.5 dB
- Total Harmonic Distortion  
PHONO to OUT (REC)  
(20 Hz to 20 kHz, 3 V) ..... 0.02% or less  
CD, etc. to SPEAKERS  
(20 Hz to 20 kHz, 35 W, 8 Ω) ..... 0.02% or less
- Signal to Noise Ratio (IHF-A Network)  
PHONO (5 mV input shorted) ..... 82 dB or more  
CD, etc. (185 mV input shorted) ..... 108 dB or more
- Residual Noise (IHF-A Network)  
PURE DIRECT ON ..... 100 μV
- Gain Tracking Error (0 to -60 dB) ..... 2 dB or less
- Input Sensitivity/Input Impedance  
PHONO ..... 3.0 mV/47 kΩ  
CD, etc. .... 185 mV/47 kΩ
- Output Level/Output Impedance  
OUT (REC) ..... 185 mV/1.2 kΩ or less  
SUB WOOFER OUTPUT ..... 4 V/1.2 kΩ or less  
ZONE 2 OUT ..... 185 mV/1.2 kΩ or less
- Headphone Output/Impedance  
(Input 1 kHz, 185 mV, 8 Ω, 0.015% THD)  
CD, etc. .... 0.47 V/390 Ω
- Channel Separation  
CD, etc. (5.1 kΩ input shorted, 1/10 kHz) ..... 65/50 dB or more
- Tone Control Characteristics  
BASS  
Boost/Cut (20 Hz) ..... ±10 dB  
Turnover Frequency ..... 350 Hz  
TREBLE  
Boost/Cut (20 kHz) ..... ±10 dB  
Turnover Frequency ..... 3.5 kHz
- Continuous Loudness Control  
Attenuation (1 kHz) ..... -30 dB

## VIDEO SECTION

- Video Signal Type  
[U.S.A., Canada and General models] ..... NTSC  
[Other models] ..... PAL
- Signal to Noise Ratio ..... 50 dB or more
- Frequency Response (MONITOR OUT)  
Composite ..... 5 Hz to 10 MHz, -3 dB

## FM SECTION

- Tuning Range  
[U.S.A. and Canada models] ..... 87.5 to 107.9 MHz  
[Asia and General models] ..... 87.5/87.50 to 107.9/108.00 MHz  
[Other models] ..... 87.50 to 108.00 MHz
- Usable Sensitivity (IHF)..... 1.0 μV (11.2 dBf)
- Signal to Noise Ratio (IHF)  
Mono/Stereo ..... 76 dB/70 dB
- Harmonic Distortion (1 kHz)  
Mono/Stereo ..... 0.2%/0.3%
- Stereo Separation (1 kHz) ..... 45 dB
- Frequency Response ..... 20 Hz to 15 kHz, +0.5/-2 dB

## AM SECTION

- Tuning Range  
[U.S.A. and Canada models] ..... 530 to 1710 kHz  
[Asia and General models] ..... 530/531 to 1710/1611 kHz  
[Other models] ..... 531 to 1611 kHz
- Usable Sensitivity ..... 300 μV/m

## GENERAL

- Power Supply  
[U.S.A. and Canada models] ..... AC 120 V, 60 Hz  
[Asia model] ..... AC 220/230-240 V, 50/60 Hz  
[General model] ..... AC 110/120/220/230-240 V, 50/60 Hz  
[Australia model] ..... AC 240 V, 50 Hz  
[Europe model] ..... AC 230 V, 50 Hz
- Power Consumption ..... 180 W
- Standby Power Consumption ..... 0.1 W
- Maximum Power Consumption [General model only]  
(8 Ω, 1 kHz, 10% THD) ..... 400 W
- AC Outlets  
[Australia model] ..... 1 (Total 100 W maximum)  
[General model] ..... 2 (Total 50 W maximum)  
[Other models] ..... 2 (Total 100 W maximum)
- Dimensions (W x H x D) ..... 435 x 151 x 308 mm  
(17-1/8" x 5-15/16" x 12-1/8")
- Weight ..... 8.7 kg (19 lbs. 3 oz.)

\* Specifications are subject to change without notice.